



# Cambridge IGCSE™

---

## CO-ORDINATED SCIENCES

0654/21

Paper 2 Multiple Choice (Extended)

October/November 2021

45 minutes

You must answer on the multiple choice answer sheet.

You will need: Multiple choice answer sheet  
Soft clean eraser  
Soft pencil (type B or HB is recommended)

---

### INSTRUCTIONS

- There are **forty** questions on this paper. Answer **all** questions.
- For each question there are four possible answers **A, B, C** and **D**. Choose the **one** you consider correct and record your choice in soft pencil on the multiple choice answer sheet.
- Follow the instructions on the multiple choice answer sheet.
- Write in soft pencil.
- Write your name, centre number and candidate number on the multiple choice answer sheet in the spaces provided unless this has been done for you.
- Do **not** use correction fluid.
- Do **not** write on any bar codes.
- You may use a calculator.

### INFORMATION

- The total mark for this paper is 40.
- Each correct answer will score one mark.
- Any rough working should be done on this question paper.
- The Periodic Table is printed in the question paper.

---

This document has **16** pages.



## 2

1 The list shows some requirements of living things.

- 1 light
- 2 carbon dioxide
- 3 water
- 4 mineral ions

What do plants need to make glucose?

- A** 1 and 2 only    **B** 2 and 3 only    **C** 3 and 4    **D** 1, 2 and 3

2 Which structure is only found in plant cells?

- A** cell membrane
- B** cytoplasm
- C** nucleus
- D** vacuole

3 Which molecule contains carbon?

- A** ammonia
- B** fat
- C** sulfuric acid
- D** water

## 3

- 4 An investigation was carried out to see the effect of pH on the activity of an enzyme found in the human alimentary canal.

The graph shows the results obtained.

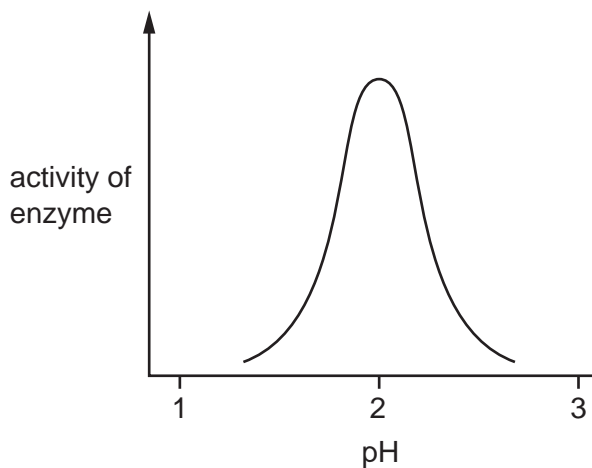

What is the enzyme?

- A a protease found in the mouth
  - B a protease found in the stomach
  - C an amylase found in the mouth
  - D an amylase found in the stomach
- 5 What will cause plant leaves to turn yellow?
- A a lack of magnesium in the soil
  - B a lack of starch in the leaves
  - C a reduction in the rate of photosynthesis
  - D a reduction in the rate of respiration
- 6 Which nutrient is well provided by citrus fruits such as oranges and lemons?
- A carbohydrate
  - B protein
  - C vitamin C
  - D vitamin D

- 7 Which row shows the state of the heart valves whilst the atria are contracting and the ventricles are relaxing?

	valves between the atria and the ventricles	valves between the ventricles and the arteries
<b>A</b>	open	closed
<b>B</b>	closed	open
<b>C</b>	open	open
<b>D</b>	closed	closed

- 8 Which diagram shows the rate and depth of breathing of a person before and during exercise?

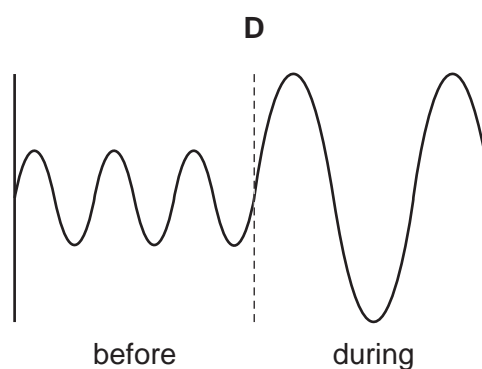
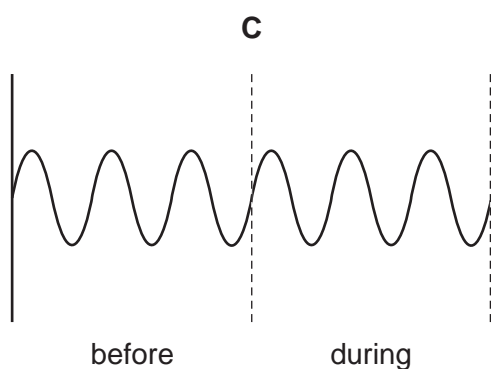
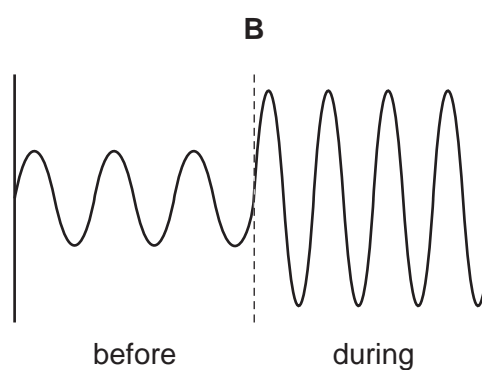
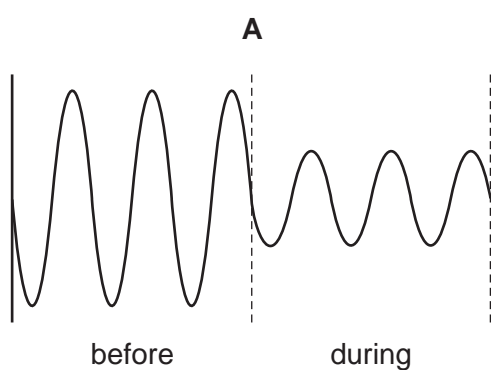

- 9 A person touches a hot object with their hand. They quickly pull their hand away.

Which statement is correct?

- A** The effector is their hand.
- B** The effector is the hot object.
- C** The receptor is in the muscles of their arm.
- D** The receptor is in the skin of their hand.

10 What is a characteristic of an insect-pollinated flower compared with a wind-pollinated flower?

	insect-pollinated	wind-pollinated
<b>A</b>	anthers inside flower	anthers outside flower
<b>B</b>	petals small	petals large
<b>C</b>	smooth pollen	sticky pollen
<b>D</b>	stigma outside flower	stigma inside flower

11 Wing length in fruit flies is controlled by a single pair of alleles.

The diagram shows the results of crosses between fruit flies.

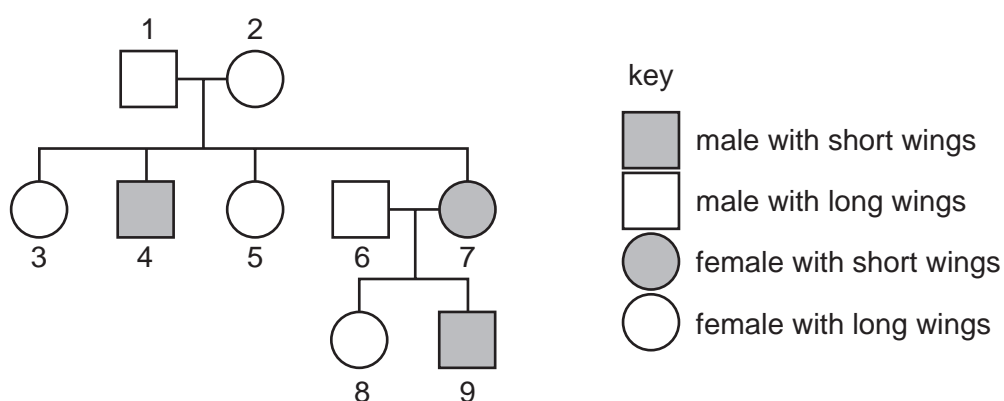

What is the probability of individuals 6 and 7 producing another offspring with long wings?

- A** 12.5%      **B** 25%      **C** 50%      **D** 75%

12 What is an ecosystem?

- A** a chart showing the flow of energy from one organism to another  
**B** a diagram giving the energy level of an organism in its environment  
**C** a network of interconnected organisms  
**D** a unit containing all of the organisms and their environment

13 The diagram shows a simplified carbon cycle.

Which labelled arrow represents respiration?

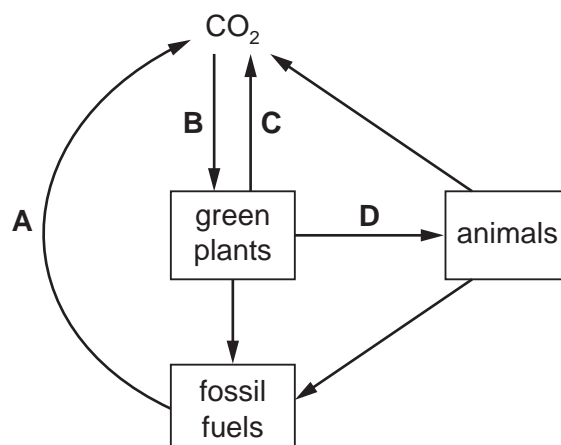

14 Which row identifies physical changes and chemical changes?

	physical changes	chemical changes
<b>A</b>	cooking an egg and ice melting	rusting of iron
<b>B</b>	ice melting and water boiling	burning wood
<b>C</b>	mixing sand and water	baking a cake and water boiling
<b>D</b>	rusting of iron and baking a cake	solid dissolving and ethanol evaporating

15 Carbon dioxide is produced in a reaction. It is collected in a gas syringe.

The readings on the gas syringe are shown.

	reading / cm <sup>3</sup>
initial	7
final	43

What is the mass of carbon dioxide gas produced?

- A** 0.0015g      **B** 0.0018g      **C** 0.0660g      **D** 0.0788g

16 The diagram shows the electrolysis of a compound.

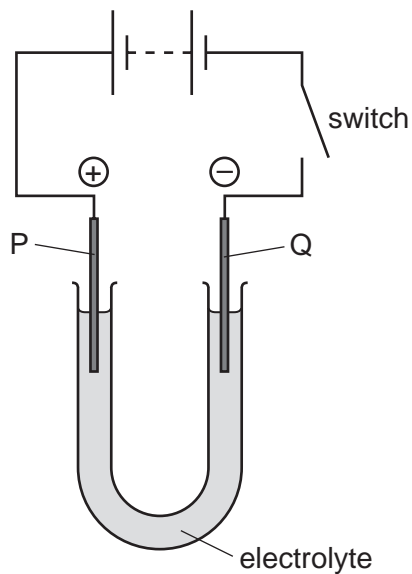

When the switch is closed, the solution around electrode P turns orange because a halogen is formed.

The positive electrode P is called the .....1....., and the halogen is .....2..... .

Which words complete gaps 1 and 2?

	1	2
<b>A</b>	anode	bromine
<b>B</b>	anode	chlorine
<b>C</b>	cathode	bromine
<b>D</b>	cathode	chlorine

17 Excess magnesium reacts with 25 cm<sup>3</sup> of 0.1 mol/dm<sup>3</sup> hydrochloric acid.

The dashed line shows the volume of gas made over time.

The experiment is repeated using excess magnesium and 25 cm<sup>3</sup> of 0.05 mol/dm<sup>3</sup> hydrochloric acid.

Which line shows the results for this experiment?

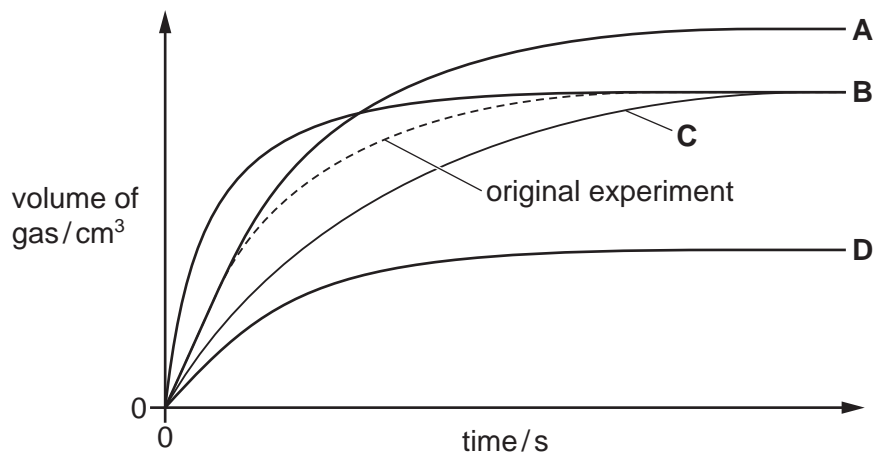

18 Which equation represents a redox reaction?

- A  $\text{CaCO}_3 \rightarrow \text{CaO} + \text{CO}_2$
- B  $\text{Cu}(\text{OH})_2 \rightarrow \text{CuO} + \text{H}_2\text{O}$
- C  $\text{LiOH} + \text{HCl} \rightarrow \text{LiCl} + \text{H}_2\text{O}$
- D  $2\text{Na} + 2\text{H}_2\text{O} \rightarrow 2\text{NaOH} + \text{H}_2$

19 Nitrous oxide, N<sub>2</sub>O, is a neutral oxide.

Which statement about nitrous oxide is correct?

- A It does not react with acids or with alkalis.
- B It reacts only with acids.
- C It reacts only with alkalis.
- D It reacts with both acids and alkalis.



20 When a small piece of potassium is placed in water, hydrogen gas is given off very quickly.

Which element reacts in a similar way?

- A copper
- B iron
- C magnesium
- D sodium

21 Why does the steel used to make a drill contain manganese?

- A to increase the density of the steel
- B to increase the hardness of the steel
- C to increase the malleability of the steel
- D to increase the melting point of the steel

22 A block of zinc is attached to an underground steel pipe as shown.

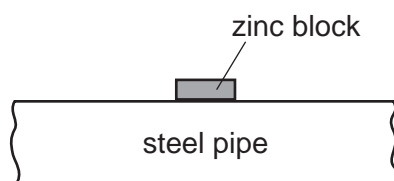

The zinc stops the steel rusting by sacrificial protection.

Which statement is **not** correct?

- A Zinc is more reactive than the iron in steel.
- B Zinc is oxidised in preference to the iron in steel.
- C Zinc prevents oxygen from reaching the steel.
- D Zinc transfers electrons to the iron in the steel.

23 Which row identifies a gas removed from exhaust emissions and a gas produced by a catalytic converter?

	gas removed	gas produced
A	carbon dioxide	carbon monoxide
B	carbon dioxide	oxygen
C	nitrogen monoxide	carbon monoxide
D	nitrogen monoxide	oxygen

24 The Contact process is used to manufacture sulfuric acid.

Which step in the Contact process is reversible?

- A sulfur reacting with oxygen
- B sulfur dioxide reacting with oxygen
- C sulfuric acid reacting with sulfur trioxide
- D oleum,  $\text{H}_2\text{S}_2\text{O}_7$ , reacting with water

25 Calcium carbonate (limestone) is a base.

Which uses of limestone depend on it acting as a base?

- 1 making lime
- 2 neutralising acid waste
- 3 stone buildings
- 4 treatment of soil

- A 1 and 2
- B 2 and 3
- C 2 and 4
- D 3 and 4

26 Four molecules are shown.

Which structure represents ethanol?

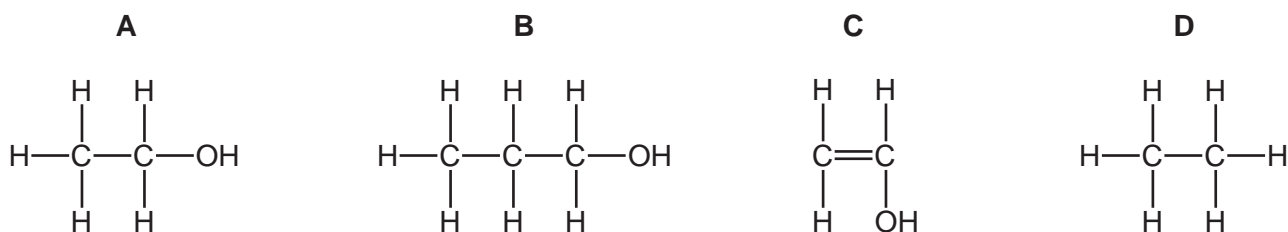

27 The cracking of decane molecules is represented by the equation shown.



What is Y?

- A  $\text{C}_4\text{H}_8$
- B  $\text{C}_4\text{H}_{10}$
- C  $\text{C}_7\text{H}_{14}$
- D  $\text{C}_7\text{H}_{16}$

- 28 A student is investigating the extension of a spring. The diagrams show the spring before and after a 0.20 N load is added.

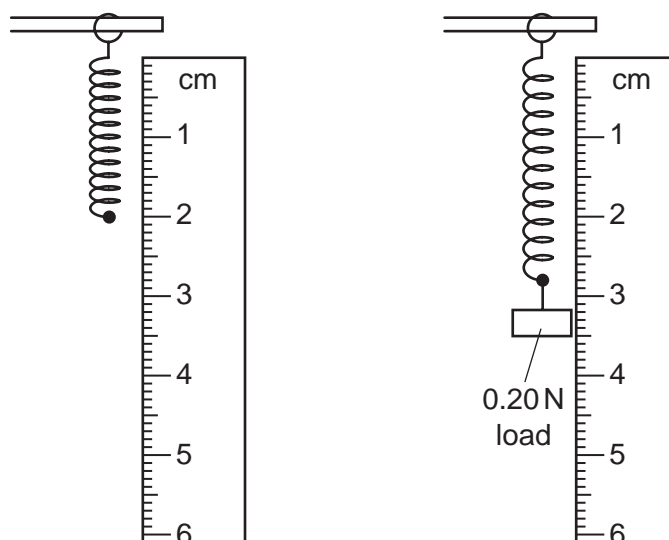

What is the spring constant of the spring?

- A 0.070 N/cm    B 0.16 N/cm    C 0.25 N/cm    D 4.0 N/cm
- 29 The table gives the weight and total area of contact with the ground of four animals.

Which animal exerts the least pressure on the ground?

	animal	weight/N	area of contact/cm <sup>2</sup>
A	beaver	270	220
B	cat	41	29
C	duck	16	72
D	mouse	0.19	0.12

- 30 A ball falls vertically downwards.

Which energy transfer takes place as the ball accelerates downwards?

- A gravitational potential to elastic potential (strain)  
 B gravitational potential to kinetic  
 C elastic potential (strain) to kinetic  
 D kinetic to gravitational potential

31 A 250 W electric motor lifts a 50 N load through a height of 4.0 m in 3.0 s.

What is the efficiency of this system of lifting the load?

- A 15%                      B 27%                      C 38%                      D 67%

32 Which labelled arrow on the diagram represents condensation?

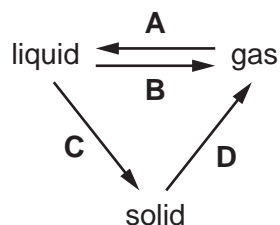

33 A sealed cylinder contains gas.

The average speed of the molecules of the gas increases but the average distance between them remains the same.

How does this affect the pressure of the gas and its volume?

	pressure	volume
<b>A</b>	decreases	increases
<b>B</b>	decreases	no change
<b>C</b>	increases	increases
<b>D</b>	increases	no change

34 Four loudspeakers vibrate at different frequencies.

Which frequency produces a sound with the largest wavelength and can be heard by a human?

- A 15 Hz                      B 150 Hz                      C 2.5 kHz                      D 25 kHz

35 The diagram shows a ray of light striking a plane mirror.

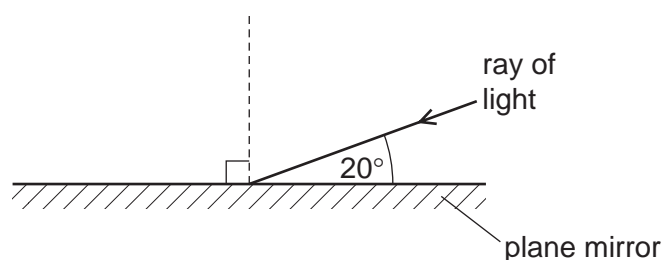

What is the angle of reflection?

- A 20°                      B 40°                      C 70°                      D 90°

36 Which diagram shows a converging lens forming a real image of an object O?

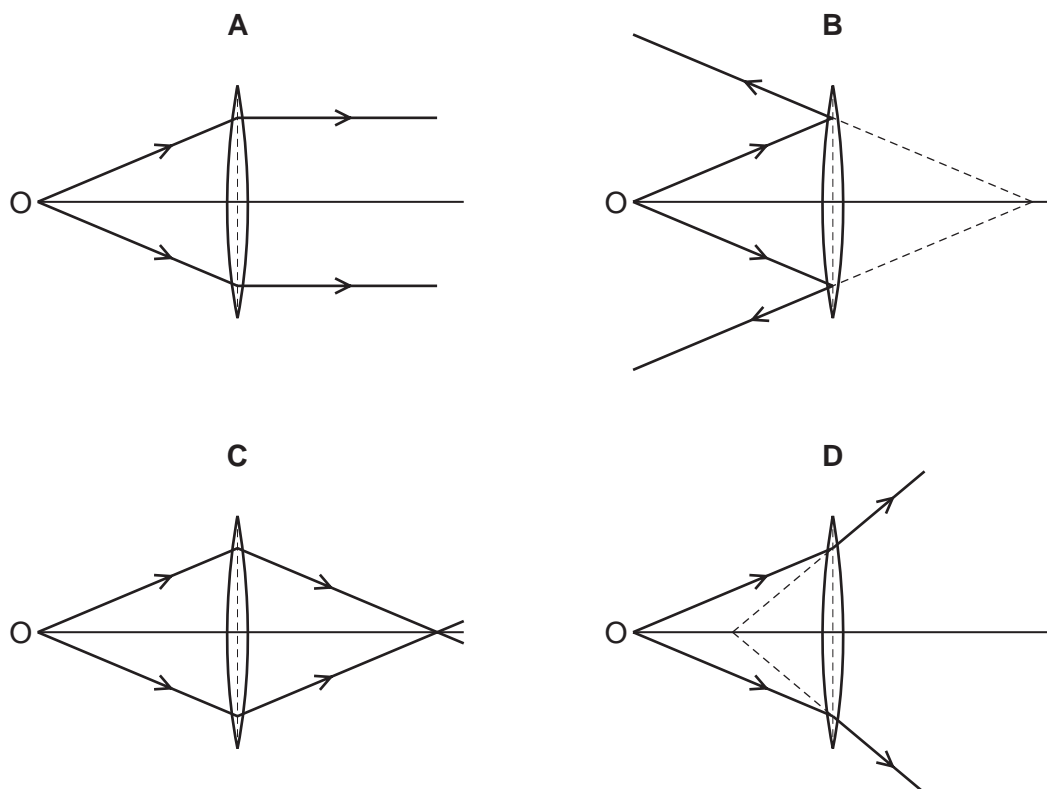

37 The diagram represents a wave in air. Molecules are closer together in region P than they are in region Q.

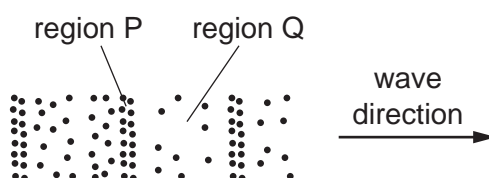

Which type of wave is represented, and in which direction do the molecules vibrate?

	type of wave	direction of vibration
<b>A</b>	longitudinal	↔
<b>B</b>	longitudinal	↕
<b>C</b>	transverse	↔
<b>D</b>	transverse	↕

- 38** A rod is rubbed with a dry piece of cloth. A scientist holds the rod in her hand and brings it close to a negatively charged plastic strip. The strip is suspended by an insulating thread.

As the rod approaches the plastic strip, the strip moves towards the rod.

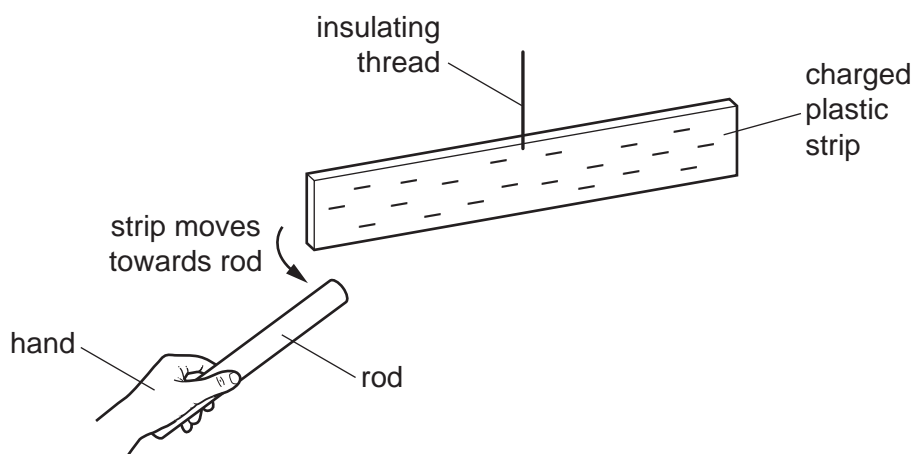

Which statement is correct?

- A** The rod is a negatively charged electrical conductor.
  - B** The rod is a negatively charged electrical insulator.
  - C** The rod is a positively charged electrical conductor.
  - D** The rod is a positively charged electrical insulator.
- 39** The diagram shows a wire carrying an electric current in the direction shown. The wire is at right angles to a magnetic field that is directed into the page.

A force acts on the wire because of the current and the magnetic field.

In which labelled direction does this force act?

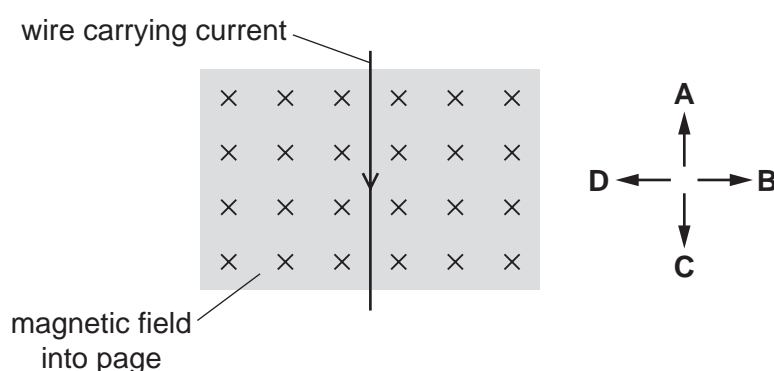

- 40 The table gives information about the deflection of radiation in an electric field and in a magnetic field.

Which row is correct?

	radiation	deflected in electric field	deflected in magnetic field
<b>A</b>	alpha	yes	yes
<b>B</b>	alpha	no	no
<b>C</b>	gamma	yes	no
<b>D</b>	gamma	yes	yes

---

Permission to reproduce items where third-party owned material protected by copyright is included has been sought and cleared where possible. Every reasonable effort has been made by the publisher (UCLES) to trace copyright holders, but if any items requiring clearance have unwittingly been included, the publisher will be pleased to make amends at the earliest possible opportunity.

To avoid the issue of disclosure of answer-related information to candidates, all copyright acknowledgements are reproduced online in the Cambridge Assessment International Education Copyright Acknowledgements Booklet. This is produced for each series of examinations and is freely available to download at [www.cambridgeinternational.org](http://www.cambridgeinternational.org) after the live examination series.

Cambridge Assessment International Education is part of the Cambridge Assessment Group. Cambridge Assessment is the brand name of the University of Cambridge Local Examinations Syndicate (UCLES), which itself is a department of the University of Cambridge.

